

# Micro Plus Ticket Printer

*Users Manual*



***Boca Systems***

INCLUDES MOUNTING  
INFORMATION FOR  
VERTICAL UNIT

## **BOCA SYSTEMS, INC.**

© 1996 Boca Systems, Inc. All rights reserved.

Under the copyright laws, this manual may not be copied, in whole or in part, without the written consent of BOCA.

Every effort has been made to ensure that the information in this manual is accurate. BOCA is not responsible for printing or clerical errors and reserves the right to change specifications without notice.

# Table of Contents

# Page

1.0	Introduction	1
2.0	Unpacking the Printer	2
3.0	A tour of your printer	3-4
4.0	Installation	5
5.0	Configuration	6
6.0.	Standard Interface Pinouts	7
7.0	Thermal Paper - Theory and Specification	8
8.0	Maintenance and Adjustments	9-14
9.0	Spare Parts List	15-16
10.	Troubleshooting Guide	17-18

# **Table of Figures and Appendices**

# **Page**

<b>Figure 1</b>	Packaging	2
<b>Figure 2</b>	Micro Plus Ticket Printer	3
<b>Figure 3</b>	Side view with door open	3
<b>Figure 4</b>	Rear view	4
<b>Figure 5</b>	Side view with electronics exposed	4
<b>Figure 6</b>	Ticket loading	5
<b>Figure 7</b>	Slider Adjustment	6
<b>Figure 8</b>	Optical Devices	10
<b>Figure 9</b>	Print head removal	12
<b>Appendix A</b>	Operator Menu options through control panel	
<b>Appendix B</b>	Site Preparation drawing	
<b>Appendix C</b>	FGL Printer Comparison Chart	

# FCC NOTICE

NOTE: The equipment has been tested and found to comply with the limits for a class A digital device, pursuant to part 15 of the FCC rules. These limits are designed to provide reasonable protection against harmful interference when the equipment is operated in a commercial environment. This equipment generates, uses, and can radiate radio frequency energy and, if not installed and used in accordance with the instruction manual, may cause harmful interference to radio communications. Operation of this equipment in a residential area is likely to cause harmful interference in which case the user will be required to correct the interference at his own expense.

Operation is subject to the following two conditions:

1. This device may not cause harmful interference, and
2. This device must accept any interference received, including interference that may cause undesired operation.

NOTE: This unit was tested with shielded cables on the peripheral devices. Shielded cables must be used with the unit to insure compliance.

# WARRANTY INFORMATION

**PRINTERS** - BOCA warrants each printer to be free of defects for a period of one year from the date of shipment when subject to normal use and service. This warranty covers all parts and labor except for the print head which is warranted for 90 days. All warranty labor is to be performed at the BOCA facility. Equipment damaged by misuse or negligence including damage to print heads caused by defective ticket stock is excluded from this warranty.

Any defective equipment meeting these conditions should be returned to BOCA for repair (freight prepaid) in its original box and packing material. A short note describing the failure should be enclosed with the printer.

Equipment damaged in shipping should be reported immediately both to BOCA and to the shipper.

**EXTENDED WARRANTY PLAN** - BOCA offers extended warranty plans for all printer models. These plans cover all parts and labor. All labor is to be performed at the BOCA facility. Equipment damaged by misuse or negligence including damage to print heads caused by defective ticket stock is excluded from this extended warranty. The customer, at his option, may request BOCA to ship individual parts to expedite simple repair procedures. In certain cases where the customer is unable to wait for the normal repair cycle, BOCA will ship an exchange printer within one business day after notification by the customer. All freight charges are the responsibility of the customer.

# 1.0 Introduction

The BOCA Micro Plus is a direct thermal ticket printer with an internal (locked) storage compartment designed for point of sale ticketing environments. This manual will provide the user with general information regarding printer set-up, configuration and troubleshooting. Please consult the programming guide for additional technical details.

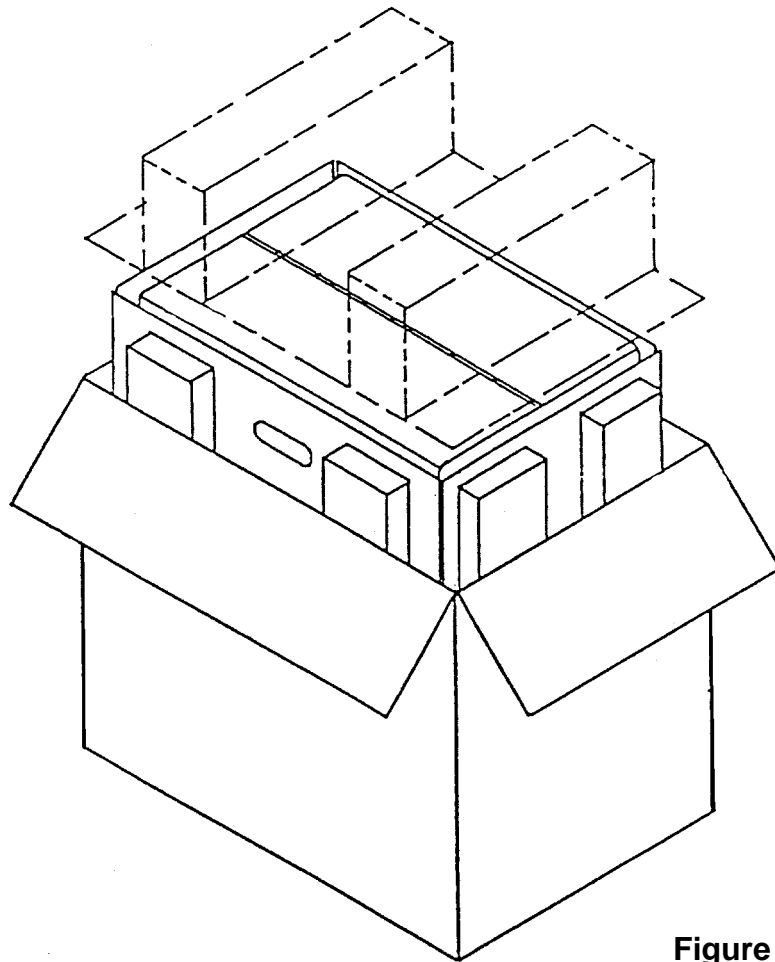
## 2.0 Unpacking the Printer

The printer is shipped in a ruggedized container. Please save packing material for future use. Remove the printer (**see figure 1**) and accessories from the box and inspect for obvious damage. If damage is noticed please report it immediately to **BOCA**.

Tel: (561) 998-9600 Fax: (561) 998-9609

The following items should be in the box:

- a) Ticket Printer
- b) Vertical mounting top plate (optional)
- c) AC power cord
- d) Interface cable (optional)
- e) Programming guide
- f) This manual



**Figure 1 - Packaging**



# 3.0 A Tour of Your Printer

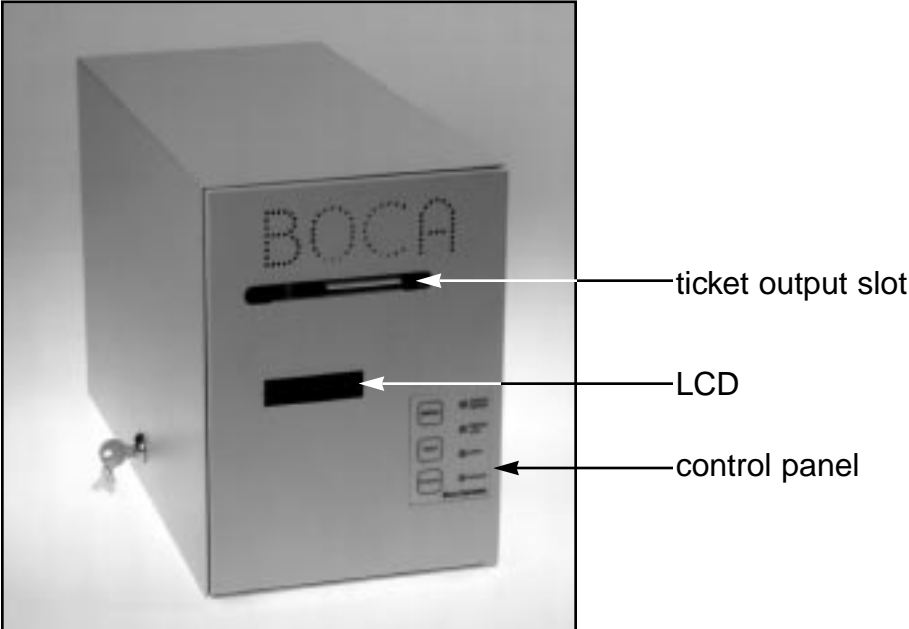


Figure 2 - Micro Plus ticket printer

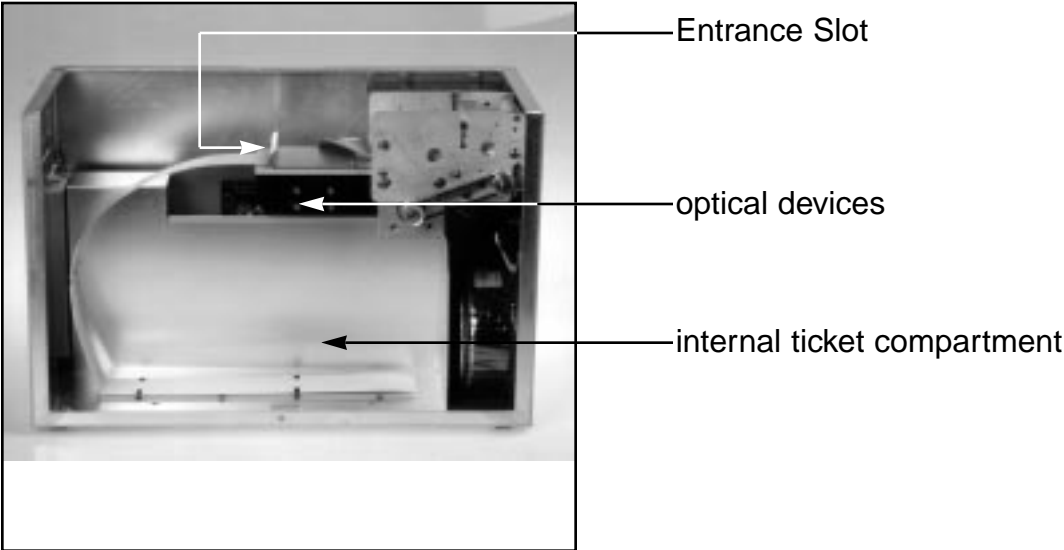
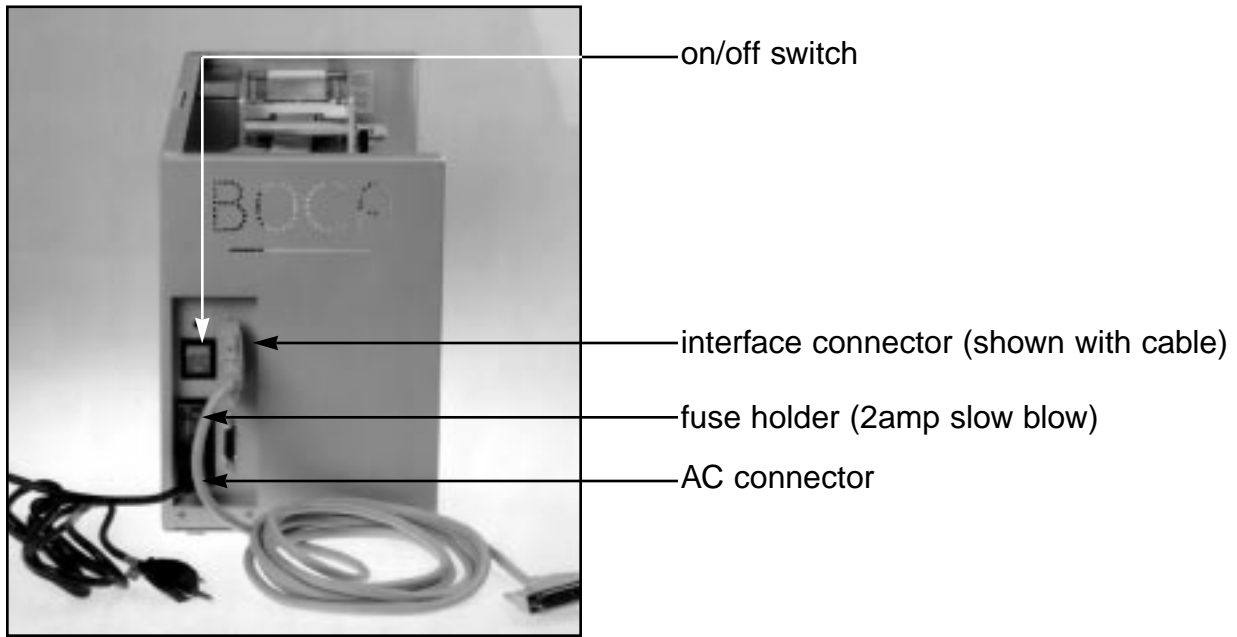
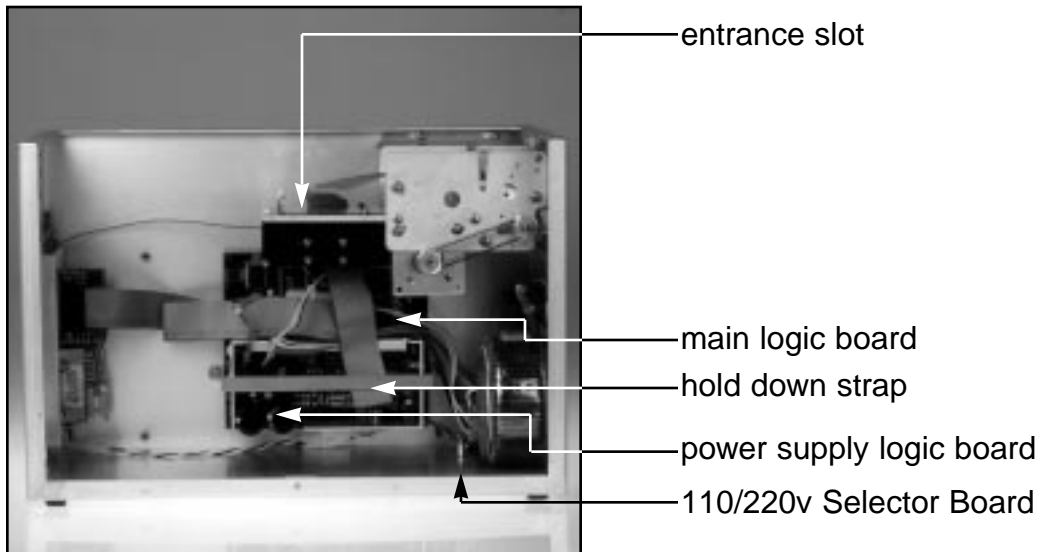


Figure 3 - Micro Plus side view



**Figure 4 - Micro Plus rear view**

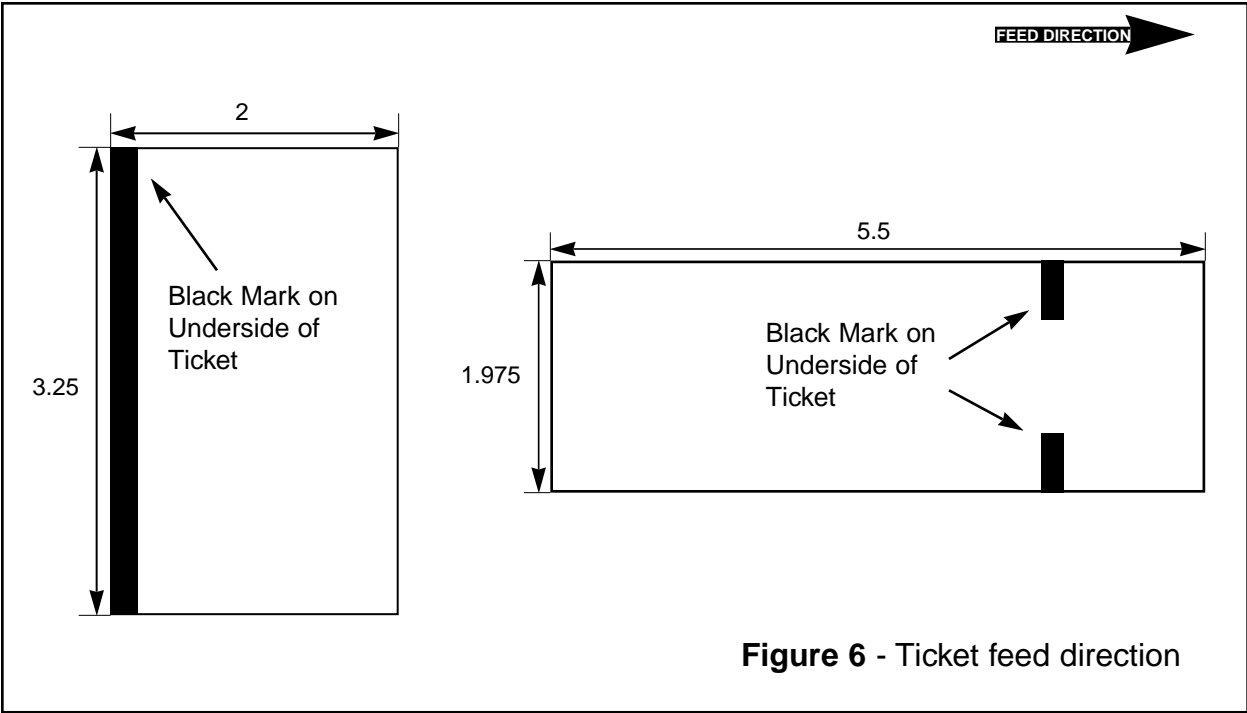


**Figure 5 - Micro Plus side view with electronics exposed**

# 4.0 Installation

The Micro Plus ticket printer is designed to be mounted on a desktop or on a shelf. The Micro Plus is available with an optional mounting plate for installation within a counter. However, prior to site preparation and installation, the printer should be powered up and run in the self test mode. Lay the printer flat on a counter as shown in **figure 3** with the cover removed. Verify that voltage selector is properly set for your line voltage (110/220v) as shown in **figure 5**. Attach the AC cord and interface connector into the proper connectors as shown in **figure 4**. Turn power on (**figure 4**). The LCD will display **PAPER OUT**. Begin loading tickets through the entrance slot (**figure 5**) with a smooth motion until the printer automatically positions the ticket.

NOTE: Tickets should be loaded with the black mark facing down. Two typical ticket formats and feed directions are shown below (**figure 6**).



After the ticket is automatically positioned (the **READY** LED will be illuminated), press the **TEST** button located on the control panel (**figure 2**) to print a test ticket. Verify that the printer properly works with your system by issuing a ticket through your computer system.

You may now install the printer in the desired location or prepare for in-counter installation using the instructions shown in appendix B. Adequate room should be provided beneath the printer for cables and ventilation.

# 5.0 Configuration

The Micro Plus is factory configured for a variety of customer requirements. The printer is available in a standard FGL20 electronics package or with an enhanced FGL40 package. Standard resolution is 200dpi and 300 dpi is available as an option. Please see **Appendix C** for the comparison of FGL 20 and 40.

The printer is available in a number of fixed ticket widths or with an optional adjustable paper path (see figure 7). The printer is factory configured for either serial or parallel interface (see pinouts in **section 6.0**).

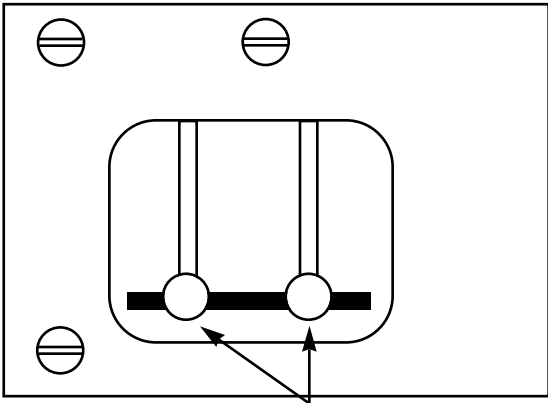
A number of other features including baud rate, cut count and print speed are also factory set but can be modified (Operator Menu) through the control panel as described in Appendix A. Most users will never have reason to change the options in the Operator Menu.

Slider Adjustment for 4.0" adjustable feature

1. Feed stock into the paper path.
2. Loosen thumb screws on slider.
3. Move slider towards the stock until it touches it.
4. Back slider away from the stock a little ( $1/32$ " )
5. Tighten thumb screws

**CAUTION:**  
Do not adjust slider tight against ticket stock. This will cause a feed problem.

Ticket stock will move from side to side if the slider is adjusted too far away from the the ticket stock.



Thumb Screws

**Figure 7 - Slider adjustment**

The diagram shows a top-down view of a slider mechanism. A horizontal bar (the slider) is positioned between two vertical guides. Two circular thumb screws are attached to the bottom of the slider, one on each side. Arrows point from the text 'Thumb Screws' to these two screws. Above the slider, there are two more circular thumb screws, one on each side, which appear to be part of the vertical guides or the frame. The entire mechanism is enclosed in a rectangular frame.

# 6.0 Standard Interface Pinouts

## 6.1 Serial Pinouts

### RS232 (Standard)

Pin	Function
2	Printer Transmit
3	Printer Receive
7	Ground
5,20	DTR (Printer Ready)
4,22	RTS (+5Vdc)

### RS232 (PC type)

Pin	Function
2	Printer Receive
3	Printer Transmit
5	RTS (+5Vdc)
6	DTR (Printer Ready)
7	Ground
8	CD (+5Vdc)

## 6.2 Typical RS232 Pin Connections

(Standard) 25 PIN PC		(Standard) 9 PIN PC		(PC Type) 25 PIN PC		(PC Type) 9 PIN PC	
BOCA	CPU	BOCA	CPU	BOCA	CPU	BOCA	CPU
2	3 RXD	2	2 RXD	2	2 TXD	2	3 TXD
3	3 TXD	3	3 TXD	3	3 RXD	3	2 RXD
7	7 GND	7	5 GND	5	5 CTS*	5	8 CTS*
20	6 DSR	20	6 DSR	6	6 DSR	6	6 DSR
20	5 CTS*	20	1 CD*	7	7 GND	7	5 GND
20	8 CD*	20	8 CTS*	8	8 CD*	8	1 CD*

\* Optional Connection

## 6.3 Parallel Pinout

Pin	Function
1	Strobe (negative)
2-9	Data (DB0-BD7)
10	ACK (negative)
11	BUSY
12	PAPER OUT
15	ERROR (negative)
18	Ground

**NOTE:** The above pinouts may vary on certain printers due to special customer request.

# 7.0 Thermal Paper - Theory & Specification

The print head's life expectancy is composed of both a mechanical and an electrical component. Both of these factors are strongly influenced by the quality of the thermal paper used.

## MECHANICAL

The print head has a theoretical rating of 60 kilometers. This number is based upon the assumption that the head will be used with a good quality, top coated thermal paper. Uncoated and poorly top coated thermal papers are abrasive to the print head and have been found to wear through the head after less than one kilometer.

Other factors which may contribute to premature mechanical wear are the use of non-thermal inks and stray metallic particles stuck in ticket perforations. Certain inks colors such as opaque white (which contains titanium dioxide) are also highly abrasive.

Unfortunately, there are no available devices for quantitatively measuring the abrasiveness of a given ticket. Fortunately, we have developed a slightly subjective, but effective method of weeding out overly abrasive ticket stock.

## ELECTRICAL

Each heat element, dot, on the print head has a theoretical life expectancy of 100 million activations. This is based on the assumption that each activation will cause the dot temperature to approach the dot's maximum recommended temperature. Running at lower temperatures will increase the theoretical life expectancy, while slight temperature increases will seriously (exponentially) degrade the head life.

The thermal paper can affect the electrical head life in two ways. Insensitive, slow to image papers, will typically encourage the user to increase the voltage to darken the printed image. This will directly increase the head temperature resulting in reduced head life. Additionally, the higher temperatures will frequently cause the ink to peel off the ticket and deposit onto the print head. The ink debris will disrupt the normal transfer of heat from the head to the paper. This further increases the head temperature above the desired level. The use of non-thermal inks and/or non-top coated papers also will cause the ink to release and deposit on the print head.

## SPECIFICATION

Based upon the above technical information, BOCA has always tried to encourage our customers to use the proper thermal papers to maximize the life of their print heads. BOCA provides an extensive series of papers which meet the above criteria for low abrasion and high sensitivity. We have also tested and approved a number of Ricoh thermal papers which meet our criteria. While we have not had the opportunity to test other manufacturers' thermal papers, we feel confident that other papers manufactured with the above goals in mind should be acceptable for use in our printers. The following list of papers have been approved by BOCA.

### 100 and 200 dpi usage

BOCA TLD7, TLD7R, TLD5, SF7, P8  
Ricoh 120TLD, 120LCSB, 120LD

### 300 dpi usage

BOCA HS7, SFHS7  
Ricoh 150TLA

Please note that the 300 dpi papers may be used on 100 and 200 dpi printers. In fact, doing so will increase the electrical life of the head as this will allow the head to operate at a lower temperature. DO NOT use 300 dpi heads with 200 dpi paper.

# 8.0 Maintenance and Adjustments

Your ticket printer is solidly constructed and has been designed for high volume use. It requires minimal care to provide maximum service.

This section provides an overview of printer maintenance, including parts alignments, adjustment and replacement.

For discussion purposes, the printer consists of two major modules or assemblies:

- Paper guide and print head assembly
- Logic board assembly

**As a safety precaution, all service to the printer should be done with power off and the AC cord unplugged from the printer.**

## 8.1 Paper Guide and Print Head Assembly

The principal function of this assembly is to guide the ticket stock to the thermal print head where thermal printing takes place. Additionally, this assembly houses the drive platen and optical detectors. If necessary, the total assembly can be removed from the unit if necessary, however, all replacements and adjustments of the components of this assembly can be done without removing the total assembly.

The most common adjustments and replacements regarding this assembly follows:

### 8.1.5 Optical Devices (see figure 8)

There are two identical opto devices mounted on a black aluminum bracket beneath the paper guide. The opto on the left controls automatic ticket loading and the opto on the right controls tear position. **Removal or adjustment of either opto should be done without removing the bracket from the paper guide.**

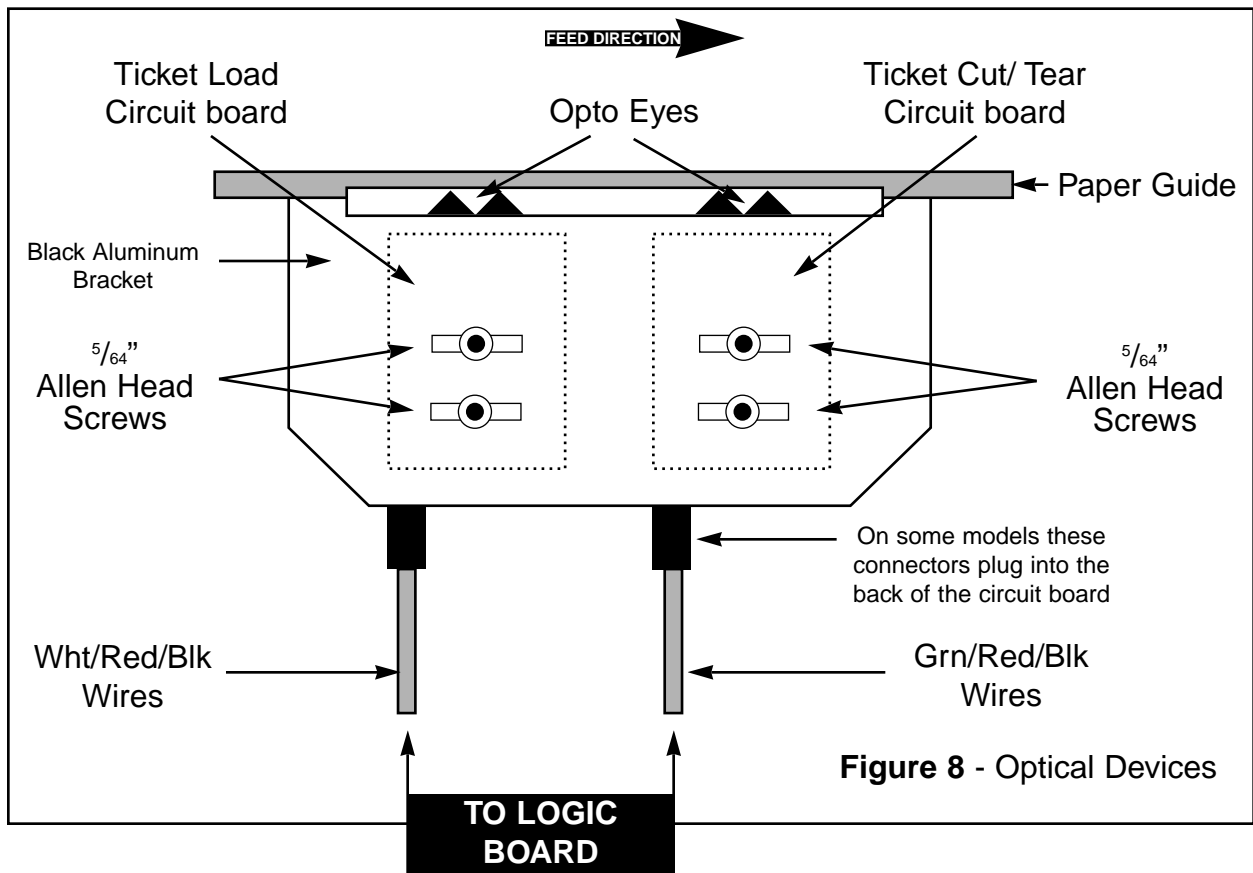
**The opto position is factory set and adjustment should not be necessary.**

**Caution:** Before making any opto adjustments make sure your ticket stock was manufactured to proper specifications.

The ticket load opto should be positioned such that the printer automatically activates the stepper motor at the proper time when tickets are loaded into the printer. When loading tickets, the stepper motor should turn on when the ticket stops in front of the thermal head. At this point, the ticket will be grabbed out of your hand and fed into the printer. If the motor does not activate, make sure the ticket stock is loaded into the printer properly. If stock is loaded in properly then re-adjust the opto position to the right (1/16" increments) until the desired position is reached. If the motor activates too soon, slide the opto towards the left.

The printer should advance the ticket just beyond the edge of the cabinet. The position of the tear can be controlled by changing the cut count setting in the **OPERATOR MENU** (see **Appendix A**). If you are not able get the desired tear position, then make sure your ticket stock was manufactured to proper specifications.

Once a year the optos eyes should be blown off with air.





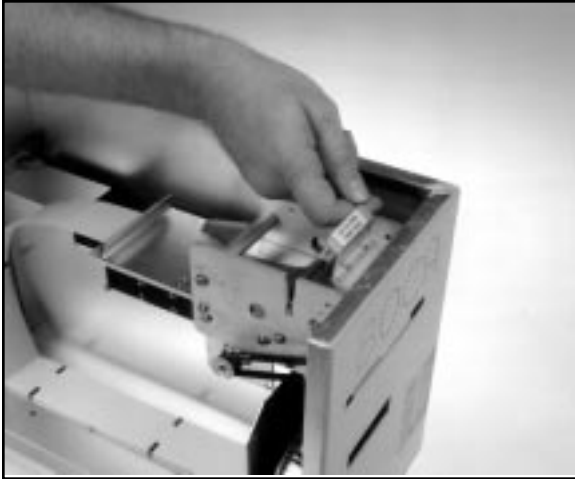
## 8.1.6 THERMAL PRINT HEAD

The print head should be cleaned periodically to prevent debris from building up on the print element. The required cleaning interval varies greatly depending on the quality of the ticket stock and the amount of dust entering the print area. Excessive dirt build up on the print head will result in reduced quality. Continuing to run the print head in a dirty condition will reduce its life expectancy as it is unable to diffuse its heat properly.

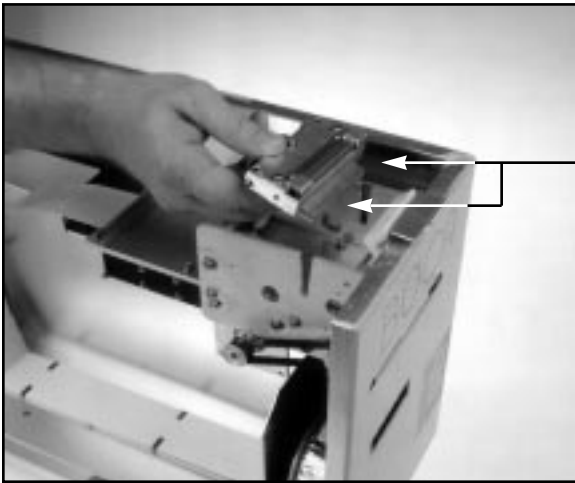
The thermal print head can be removed for cleaning or replacement, as follows:

(Please refer to **figures 9a - c**)

1. Make sure power is off and the AC cord is disconnected from the printer.
2. **DO NOT UNPLUG CABLE FROM PRINT HEAD.**
3. Lift up on the cam lock assembly (located above the head mounting block) to remove pressure from the thermal head. (see **figure 9a**)
4. Lift up on the head mounting block/thermal head to remove. (see **figure 9b**)
5. Clean the thermal print head surface (the side that makes contact with the paper) with isopropyl alcohol. (see **figure 9c**)
6. Install the head by reversing the above procedures.
7. Restore pressure to the head by pushing down on the cam lock assembly.
8. The printer is now ready for operation. If the print quality is still poor then the thermal head needs to be replaced.
9. To replace print head remove ribbon connector from print head and then remove print head from mounting block by removing two unmarked screws.

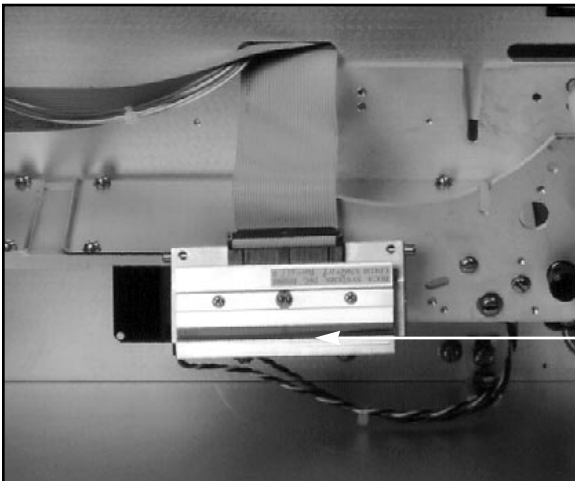


**Figure 9a** - Print Head removal



Remove these two unmarked screws to replace print head.

**Figure 9b** - Print Head removal



Clean this surface.

**Figure 9c** - Print Head removal

## 8.1.7 Rubber Drive Roller (Platen)

The rubber drive roller should be cleaned once a year to prevent paper dust from building up on the roller. Clean drive roller with a paper towel and alcohol.

1. Unlock the thermal head and tilt back to gain access to platen.
2. Clean the full length of the platen.
3. Rotate the platen clockwise and repeat step 2, continue in the same manner for one full revolution of the platen.
4. Close or lock the thermal head. Printer is now ready for normal operation.  
(NOTE: The platen may require more frequent cleaning in dusty environments or when using inferior ticket stock.)

## 8.3 Logic Board and Power Supply Board

The printed circuit boards used in this product have been manufactured using surface mount technology. The printed circuit boards cannot be effectively repaired in the field and should be returned to the manufacturer if repair is required.

Your printer has two large printed circuit boards. The Power Supply Logic Board plugs into the Main Logic Board. This section describes board removal and proper installation. **ALL SERVICE SHOULD BE DONE WITH POWER OFF AND THE AC CORD UNPLUGGED FROM THE PRINTER.**

### **8.3a Power Supply Logic Board (Removal)**

1. Gain access to the Logic Board Assembly by removing the sheet metal ticket tray.
2. Remove the Logic Board Assembly “hold down strap”. **(see figure 5)**
3. Unplug connectors going to the power supply logic board.
4. Unlock power supply board by pulling up and away from the 40 pin connector and the two brass fasteners.
5. Lift board and remove.

### **8.3b Power Supply Logic Board (Installation)**

1. Align holes on Power Supply Board with the 40 pin connector and the brass fasteners and press straight down.
2. Press down in the area of connector JCUT to properly seat board.
3. Attach connectors going to the power supply logic board.
4. Install Logic Board Assembly “hold down strap.”

### **8.3c Main Logic Board (Removal)**

1. Remove the Power Supply Logic Board as described in section **8.3a**.  
All connectors on the Power Supply Logic Board should stay attached.
2. Unplug connectors going to the main logic board.
3. Use a screwdriver to gently wedge logic board from the fasteners.
4. Lift board and remove.

### **8.3d Main Logic Board (Installation)**

1. Align Main Logic Board so that the four mounting holes are above the four fasteners.
2. Press logic board straight down onto the brass fasteners.
3. Attach connectors going to the main logic board.
4. Install Power Supply Logic Board as described in section **8.3b**.

## **8.4 General Cleaning**

The interior of the printer should be cleaned whenever there is a visible accumulation of dust. Use a small vacuum for cleaning. Be careful not to jar any of the printer's parts loose.

## 9.0 Spare Parts List

PART #	DESCRIPTION
P19-1000	AC CORD
P31-1000	AC FILTER
492121	ANTI STATIC BRUSH (2" OR 3.25")
P45-1009 B	EARING, EJECT BLOCK (LARGE)
04107GMN	BEARING, EJECT MOTOR
422557-188	CABLE RIBBON, THERMAL HEAD (BS2008)
422557-18	CABLE RIBBON, THERMAL HEAD (3.25" & 4.0") 18"
422557-16	CABLE RIBBON, THERMAL HEAD (3.25" & 4.0") 16"
422558-16	CABLE RIBBON, THERMAL HEAD (BS2002 & BS3002)
422558-11	CABLE RIBBON, DATA CABLE
422558-11C	CABLE RIBBON, DATA CABLE (dual I/O ports)
422559-13	CABLE RIBBON, CONTROL PANEL 13"
422559-9	CABLE RIBBON, CONTROL PANEL 9"
421414-2	CABLE, THERMAL HEAD (3.25") For 421570 PCB's
421212-1	CABLE, THERMAL HEAD (2.00") For 421570 PCB's
420881VW6SC2	COVER, VGH08 3.25" 200DPI SC2
432020	CAM LEVER, PAPER GUIDE
09-18-5061	COVER MTG. HARDWARE (SCREW, FL,LW)
421671	CONNECTOR, J7 on 421570 & 421818 logic boards
421671-1MIN	CONTROL PANEL
422560-1	CONTROL PANEL, COVER COMPLETE (Mini MB)
422560-2	CONTROL PANEL DECAL, MINI MB
422560-3	CONTROL PANEL DECAL, FGL40 & FGL20 (vertical)
421682-**	CONTROL PANEL DECAL, FGL40 & FGL20 (horizontal)
P50-1008	DEFLECTOR, PAPER GUIDE (** Printer Dependent )
P50-1012	DRIVE BELT, 110T
P50-1003	DRIVE BELT, 105T
P50-1011	DRIVE BELT, 102T
P51-1002	DRIVE BELT, 100T
P51-1011	DRIVE PULLEY, 32T
P51-1010	DRIVE PULLEY, 30T
P51-1007	DRIVE PULLEY, 22T
P33-1005	DRIVE PULLEY, 20T
422076	EJECT MOTOR ASSY.
421597V4	EXIT DEFLECTOR, VERTICAL (UPPER)
28F001	MINISC EXIT DEFLECTOR, VERTICAL (LOWER)
421828-2	FLASH MEMORY
421828-1	FLASH EXPANSION BOARD ( 2MEG)
422506	FLASH EXPANSION BOARD ( 1MEG)
P54-1002	FLASH EXPANSION BOARD ( 1MEG) FGL 40 or FGL 20
P54-1011	FAN, EXHAUST
P54-1050	FAN COVER, FILTER HOLDER
431022-2	FILTER, FAN
431022-3	FLIP UP DOOR KIT (2.00")
431022-4	FLIP UP DOOR KIT (3.25")
P40-1012	FLIP UP DOOR KIT (4.00")
P29-1002	HOLD DOWN PLATE SCREW
421359-1TOH	FUSE, 2A SB
421359-2TOH	HEAD MTG. BLOCK 2.00" TAKE OUT HEAD ASSY.
421359-3TOH	HEAD MTG. BLOCK 3.25" TAKE OUT HEAD ASSY.
422190-1	HEAD MTG. BLOCK 4.00" TAKE OUT HEAD ASSY.
422190-2	INTERFACE BOARD, PARALLEL ( for FGL 40 & FGL 20)
422190-3	INTERFACE BOARD, PC serial ( for FGL 40 & FGL 20)
KN-500B	INTERFACE BOARD, SERIAL std. (for FGL 40 & FGL 20)
P49-1009	KNOB, DRIVE ROLLER ASSY.
TM161A	LATCH POST, CABINET (MINI PLUS)
422589-20	LCD DISPLAY (for FGL 40 & FGL 20)
	LCD DISPLAY CABLE

PART #	DESCRIPTION
P55-1002	LOCK, MINI PLUS (#305)
422270	LOGIC BOARD ASSY. (only) FGL 40
422188	LOGIC BOARD ASSY. (only) FGL 20
422189	LOGIC BOARD, POWER SUPPLY ( for FGL 40 & FGL 20 )
430894	LOGIC BOARD, MTG. CLIPS
421428	OPTO MTG. BRACKET
422264	OPTO DETECTOR ASSY. (surface mtg. IC's)
422007-F	OPTO DETECTOR, ATM FEED
422007-C	OPTO DETECTOR, ATM TEAR OR CUT
	OPTO MTG. HARDWARE (SCREW, FW, LW)
421366-1WHMIC	Paper Guide Top Plate w/ guide rollers
422234	PLATEN 1.328" SPECIAL
4215085M2	PLATEN 2.00" 200 OR 300 DPI
4215085M3	PLATEN 3.25" 200 OR 300 DPI
4215085M4	PLATEN 4.00" 200 OR 300 DPI
B421943	POWER DOWN PROTECTION BD. FGL IV
B421946	POWER DOWN PROTECTION BD. FGL II
421370-5M	PRESSURE BLOCK ASSY.
KF2002	PRINT HEAD, THERMAL (2.00" 200 DPI)
* BS2002	PRINT HEAD, THERMAL (2.00" 200 DPI)
BS3002	PRINT HEAD, THERMAL (2.00" 300 DPI)
KF2003	PRINT HEAD, THERMAL (3.25" 200 DPI)
* BS 2003	PRINT HEAD, THERMAL (3.25" 200 DPI)
BS3003	PRINT HEAD, THERMAL (3.25" 300 DPI)
KF2004	PRINT HEAD, THERMAL (4.00" 200 DPI)
* BS2004	PRINT HEAD, THERMAL (4.00" 200 DPI)
BS3004	PRINT HEAD, THERMAL (4.00" 300 DPI)
KF2008	PRINT HEAD, THERMAL (8.00" 200 DPI)
* BS2008	PRINT HEAD, THERMAL (8.00" 200 DPI)
421639-4	SILENT CUTTER ASSY. 4"
421639-8	SILENT CUTTER ASSY. 8"
P33-1006	SILENT CUTTER MOTOR (ONLY)
P33-1006-G	SILENT CUTTER MOTOR WITH GEARS
	SILENT CUTTER MOTOR GEAR BOX (ONLY)
422371-1	SILENT CUTTER MOTOR PINION GEAR
420816-5M4SC2	SILENT CUTTER MTG. BRACKET
P28-1015	SILENT CUTTER MICRO SWITCH
421555	SILENT CUTTER RELAY BOARD
P44-1011	SPRING, PRESSURE ADJ. BLOCK
422590	STEPPER MOTOR ASSY. (FGL40 & FGL 20)
P28-1013	SWITCH, POWER (4 tab)
P28-1012	SWITCH, TEST
421724	TAKE OUT HEAD CAM LOCK ASSY. (Complete)
421421-VM2	TOP PLATE, STD (MINI 2.00", 11.68" x 13.00")
421421-WMST	TOP PLATE, STD (MINI 3.25", 11.68" x 13.00")
421421-4	TOP PLATE, STD (MINI 4.00", 11.68" x 13.00")
421421-WSPEC	TOP PLATE, FULL SIZE (MINI 3.25", 14.5" x 14.5" )
421444	TOP PLATE, MINI PLUS (2.00")
421500-SM	TRANSFORMER, TORIOD (FGL40 & FGL 20)

As of December/95 the 422264 opto took the place of the 421056 opto.

# 10.0 Troubleshooting Guide

This is a simplified troubleshooting guide listing some of the typical problems. It is not intended to provide technical details or repair methods, but can serve as a guide to fault isolation in the field. If you need additional help, please contact **BOCA** at  
Tel: (561) 998-9600 Fax: (561) 998-9609

## 1. NO OPERATION, POWER INDICATOR IS OUT

- a. Check the power cord for proper installation at both ends.
- b. Check main fuse and replace if blown. (2amp, 250 volt, SB)
- c. Check that there is power at the AC receptacle.
- d. If main fuse keeps blowing then check that the printer's AC voltage board is set for the correct voltage.

## 2. POWER IS ON BUT NO OPERATION

- a. Check all electrical connections on the printer.
- b. Unplug the thermal head and turn on the printer.  
If printer works, replace the thermal head.
- c. Replace the Power Supply board.
- d. Replace the Main logic board.

## 3. POWER IS ON BUT TICKET WILL NOT LOAD

- a. See # 2
- b. Make sure the print head/cam lock assembly is fully locked in the closed position.  
Consult "**Thermal Print Head**" in **Section 8.1.6**.
- c. Check that the ticket stock is being loaded correctly.
- d. With printer powered on feed the ticket stocking into the printer until it stops.  
Depress the test button a couple of times. If the printer reset the ticket stock properly then the feed opto position needs to be adjusted. Consult "**Optical Devices**" in **Section 8.1.5**.
- e. Replace ticket load opto.
- f. Replace ticket tear opto.
- g. Replace the Power Supply board.
- h. Replace the Main logic board.

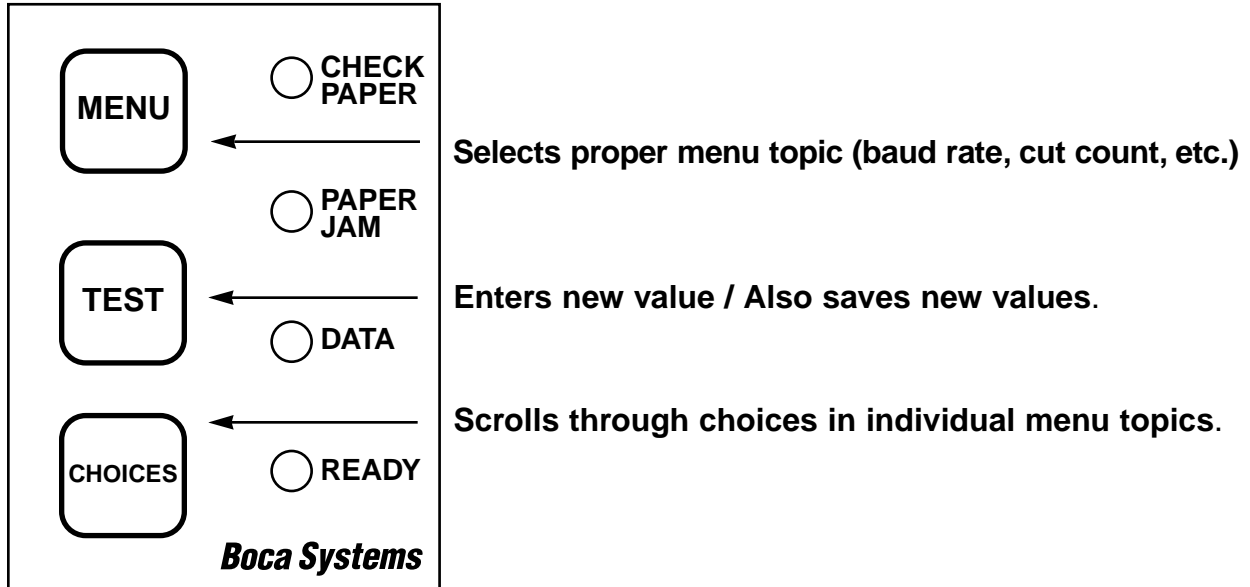
## 4. ERRATIC TEAR POSITION

- a. Check for defective ticket stock. Is the black mark unevenly spaced apart or light in color? Is the ticket too wide for the paper path?
- b. Clean off opto eyes. Consult "**Optical Devices**" in **Section 8.1.5**.
- c. Check that the platen is clean. Consult "**Rubber Drive Roller**" in **Section 8.1.7**.
- d. Replace ticket TEAR opto.
- e. Replace ticket load opto.
- f. Replace the Power Supply board.
- g. Replace the Main logic board.

- 5. ERRACTIC PRINT POSITION**
  - a. See # 4
  
- 6. POOR PRINT OUT** (light print out)
  - a. Make sure the print head/cam lock assembly is fully locked in the closed position.
  - b. Consult “**Thermal Print Head**” in **Section 8.1.6**.
  - c. Clean print head. Consult “**Thermal Print Head**” in **Section 8.1.6**.
  - d. Adjust print intensity setting via the control panel (see **Appendix A**)
  - e. Replace thermal head.
  
- 7. POOR PRINT OUT** (white voids in print out)
  - a. Clean print head. Consult “**Thermal Print Head**” in **Section 8.1.6**.
  - b. Replace thermal head.
  
- 8. NO PRINT OUT**
  - a. Check head cable for electrical connection at both ends
  - b. Check to make sure head cable is plugged in properly into the thermal head.
  - c. Replace the thermal head.
  - d. Replace the Power Supply board.
  - e. Replace the Main logic board.
  
- 9. PRINTER SKIPS TICKETS WHILE PRINTING**
  - a. Check all electrical connections on the printer.
  - b. Check position and quality of black mark on the ticket stock.
  - c. Clean off opto eyes. Consult “**Optical Devices**” in **Section 8.1.5**.
  - d. Replace ticket cut opto.
  - e. Replace ticket feed opto.
  
- 10. PRINTER SKIPS TICKETS AND DIES**
  - a. See # 9.



The FGL20 and FGL40 printers allow the user to adjust various printer options through the control panel.



**To access and use the OPERATOR MENU, follow these steps:**

1. Ticket stock should be loaded into the printer. The LCD window displays **FGL40B# or FGL20B#** (# - revision number, incremented for minor revisions ( **B** - revision letter, incremented for major revisions)
2. Press both **MENU** and **TEST** switches simultaneously for about three seconds. The LCD window displays **OPERATOR MENU!** .
3. To scroll through the menu topic, use **MENU** stopping on the topic you wish to change.
4. Press **CHOICES** to scroll through choices in the selected topic. **NOTE:** The printer displays a blinking cursor for the values presently stored in the printer.
5. Once you have found the new value you want, press **TEST**. The LCD window displays **EXIT AND SAVE?**. If you wish to save the new value, press **TEST** again.
6. If you do not wish to save the new value, press **MENU**. The LCD window displays **JUST EXIT?**. Press **TEST** to exit the **OPERATOR MENU** without saving new values or press **MENU** to enter back into the **OPERATOR MENU**.

The chart below lists the present menu topics. These topics are subject to change.

<b>OPERATOR MENU!</b>
<b>BAUD RATE?</b>
<b>MINI/MICRO?</b>
<b>PRINT SPEED?</b>
<b>DIAGNOSTIC MODE?</b>
<b>TICKET TYPE?</b>
<b>STATUS ENABLED?</b>
<b>TRANSPARENT MODE</b>
<b>PAPER MODE?</b>
<b>INC CUT1 COUNT?</b>
<b>DEC CUT1 COUNT?</b>
<b>INC CUT2 COUNT?</b>
<b>DEC CUT2 COUNT?</b>
<b>PRINT MODE?</b>
<b>PRINT INTENSITY?</b>
<b>EXIT AND SAVE</b>
<b>JUST EXIT</b>

The following is an overview of what each Menu option does:

**BAUD RATE?** Controls the serial interface baud rate, parity bit, data bits and stop bits.

Here are the following choices:

1200,N,8,1
1200,E,7,1
2400,N,8,1
2400,E,7,1
4800,N,8,1
4800,E,7,1
<b>9600,N,8,1</b>
9600,E,7,1
19200,N,8,1
19200,E,7,1

(factory default)

**MINI/MICRO?** Defines the type of printer.

**MINI** Is for a printer with a Silent Cutter Assembly (SC2) ( Mini, Mini Plus, Mini MB, Dual Mini)

**MICRO** Is for a printer without a SC2 (Micro, Micro Plus, Micro MB, Dual Micro)  
**(factory default)**

**PRINT SPEED?** Controls the speed the ticket travels at. Also effects the print quality.

The numbers range from **0 - FASTEST** to **7 - SLOWEST**. **3 is factory default.**

**DIAGNOSTIC MODE?** Please consult your Programming Guide

Your choices are **YES** or **NO**. **NO is factory default.**

**TICKET TYPE?** Defines how the optos are configured on the paper guide assembly.

**NORMAL** Both optos are inline with each other (usually mounted on a black bracket)  
**(factory default)**

**ATM** Feed opto is mounted under the thermal head and cut opto is attached to the cutter assembly.

**LABEL** Same as ATM but the cut opto is a see through type.

**SPECIAL TICKET** This option is for a Micro MB printer

**STATUS ENABLED?** Enables or disables the X-ON/X-OFF and status response protocols.

Your choices are **YES** (Enabled) or **NO** (Disabled). **YES is factory default.**

**TRANSPARENT MODE?** Please consult your Programming Guide

Your choices are **YES** (Enabled) or **NO** (Disabled). **NO is factory default.**

**PAPER MODE?** Is generally used only for test purposes. It may also be used on roll stock with no black marks on the ticket.

Your choices are **YES** (Enabled) or **NO** (Disabled). **NO is factory default.**

**INC CUT1 COUNT?** Enables the operator to move the cut or tear position to the left (towards the ticket entrance area). Cut counts are increments of .003" for 300dpi and .002" for 200dpi. The count value is changed by depressing **CHOICES**. **16 is factory default.**

**DEC CUT1 COUNT?** Enables the operator to move the cut or tear position to the right (towards the ticket exit area). Cut counts are decrements of .003" for 300dpi and .002" for 200dpi. The count value is changed by depressing **CHOICES**. **16 is factory default.**

**INC CUT2 COUNT?** Same as **INC CUT1 COUNT?** but effects path #2 on a dual path printer.

**DEC CUT2 COUNT?** Same as **DEC CUT1 COUNT?** but effects path #2 on a dual path printer.

**PRINT MODE?** Defines the automatic ticket length calculation feature.

**THERMAL** The printer will feed out and then retract a ticket during this measurement. **(factory default)**

**RIBBON** The printer will feed out one blank ticket. This mode is used for label stock to prevent peeling.

**PRINT INTENSITY?** Controls the darkness of ticket print out.

Here are the following choices:

LIGHT
MED LIGHT
<b>NORMAL</b>
MED DARK
SHORT HEAD LIFE

**(factory default)**

**EXIT AND SAVE !** Will save any changes made to the above menu options.

If you wish to save the new value then press **TEST**, if not press **MENU**.

**JUST EXIT?** Will exit the menu options without saving any changes.

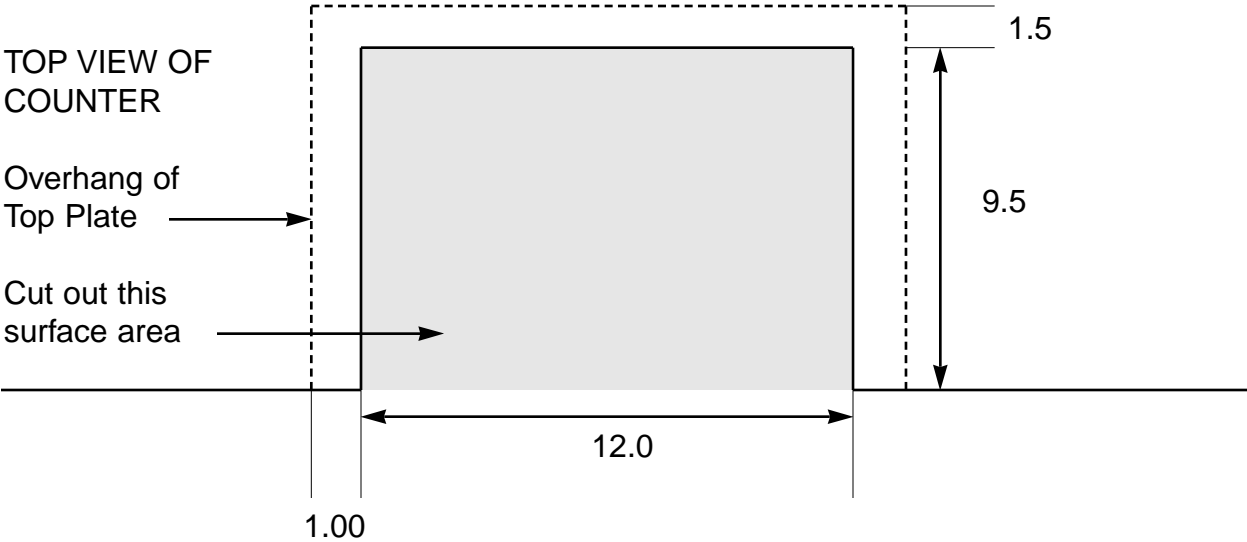
If you wish to exit without saving the new value then press **TEST**, if not press **MENU**.

# INSTALLATION INSTRUCTIONS

## Vertical Micro Plus

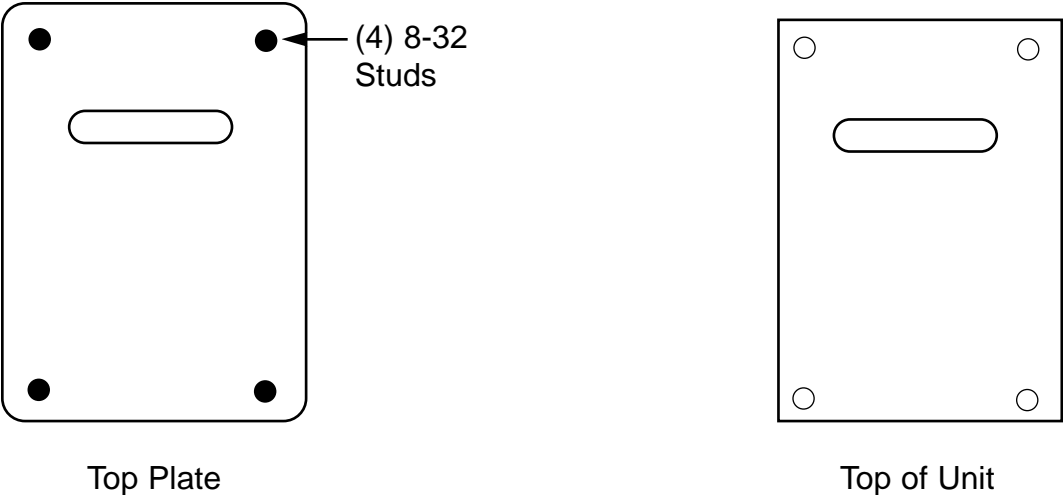
### SITE PREPARATION

Note: This Printer extends 17.0 inches below the top of the counter.



### TOP PLATE INSTALLATION

NOT TO SCALE



1. Attach Top Plate to Top of Unit so that studs protrude thru Top of Printer.
2. Tighten with 8-32 hex nuts and washers (provided) using 5/16 wrench.

**Appendix B - Site Preparation drawing**

## **FGL PRINTER COMPARISON CHART**

	<b>FGL 20</b>	<b>FGL 40</b>
Alphanumeric LCD Display	Y	Y
Processing Speed (FGL II = 1)	2	12
Customer Accessible Flash Memory	128 kbytes	128 kbytes
Expansion Memory Option	N	Y
Maximum Print Speed	8 ips	10 ips
Maximum Print Density	300 dpi	300 dpi
Maximum Printable Area @ 200 dpi	44	84
Maximum Printable Area @ 300 dpi	22	42
PCL4 Interface Option	N	Y
PCL5 Interface Option	N	future
Softfont (Hybrid) Option	N	Y
Full FGL font set	N	Y
Scaleable FGL Fonts	?	Y
PCX Graphics	?	Y
FGL Graphics	Y	Y
Asian Font Option (Japanese, Chinese, etc.)	N	Y
FGL Interface	Y	Hybrid
Magnetics Option	future	Y
Dual Option	Y	Y
Two Sided Option	N	Y
Real Time Clock Option	N	future